



Typical Features

- ◆ Wide input voltage range 4:1
- ◆ Efficiency up to 91%
- ◆ Low no-load power consumption
- ◆ Operating temperature from -40°C to +105°C
- ◆ High isolation voltage 3000VAC (input-output) & 2100VAC (input-case)
- ◆ Input under voltage protection, output over voltage, short circuit, over current & over temp protections
- ◆ Standard 1/4 brick size

ZCD150-110S24A-TS is a high-performance modular DC-DC converter with the rated input voltage 110VDC (full range from 43V to 160VDC), regulated single output 24V/150W without minimum load limit. It has the advantage of high isolation voltage, operating temperature up to 105°C Max, with the input under voltage protection, output over current, over voltage, over temperature and short circuit protections, input ON/OFF control, output voltage distal end compensation and output voltage Trim, etc.

Typical Product List

Part No.	Input voltage range (VDC)	Output power (W)	Output voltage (VDC)	Output current (A)	Ripple & Noise (mVp-p)	Full load efficiency (%) Min/Typ.	Remarks
ZCD150-110S24AC-TS	43 - 160	150	24	6.25	240	89/91	Standard Positive logic
ZCD150-110S24AN-TS							Standard Negative logic

Note: The output power should be derated linearly when the input is within the range of 43-66V. The maximum output power is 100W at 43V input.

Input Specifications

Item	Operating conditions	Min.	Typ.	Max.	Unit
Max input current	Input voltage 43V, output 100W	--	--	3	A
No load input current	Rated input voltage	--	--	10	mA
Input Inrush voltage (1sec. max.)	The unit could be permanently damaged by input over this Voltage	-0.7	--	185	VDC
Start-up voltage		--	--	43	
Input under voltage protection	With No-load (The over current protection will work in advance at full load)	--	--	42	
ON/OFF Control (CNT)	Positive logic: CNT no connection or connected to 3.5-15V to turn ON, connected to 0-1.2V to turn OFF the converter Negative logic: CNT no connection or connected to 3.5-15V to turn OFF, connected to 0-1.2V to turn ON the converter				Reference voltage -Vin

Output Specifications						
Item	Operating conditions		Min.	Typ.	Max.	Unit
Output voltage accuracy	Nominal input voltage, 10%-100% load		--	±0.5	±1.0	%
Line regulation	Full load, input voltage from low to high		--	±0.1	±0.2	
Load regulation	Nominal input voltage, 10%-100% load		--	±0.2	±0.5	
Transient recovery time	25% load step change (step rate 1A/50uS)		--	200	250	uS
Transient response deviation			-5	--	+5	%
Temperature drift coefficient	Full load		-0.02	--	+0.02	%/°C
Ripple & Noise	20M bandwidth, with external capacitor >220uF		--	120	240	mVp-p
Output voltage adjustment (TRIM)			-20	--	+10	%
Output voltage distal end compensation (Sense)			--	--	5	%
Over temperature protection	Maximum temperature of the metal base		105	115	125	°C
Over voltage protection			125	--	140	%
Over current protection			6.5	--	8.7	A
Short circuit protection			Hiccup, continuous, self-recovery			

General Specifications						
Item	Operating conditions		Min.	Typ.	Max.	Unit
Isolation voltage	I/P-O/P	Test 1min, leakage current <3mA	3000	--	--	VAC
	I/P-Case	Test 1min, leakage current <3mA	2100	--	--	VAC
	O/P-Case	Test 1min, leakage current <3mA	500	--	--	VAC
Insulation resistance	I/P-O/P	@ 500VDC	100	--	--	MΩ
Switching frequency			--	250	--	KHz
MTBF			150	--	--	K hours

Environmental characteristics						
Item	Operating conditions		Min.	Typ.	Max.	Unit
Operating temperature	Refer to the temperature derating graph		-40	--	+105	°C
Storage humidity	No condensing		5	--	95	%RH
Storage temperature			-40	--	+125	°C
Pin soldering temperature	1.5mm from the case, soldering time <1.5S		--	--	+350	
Cooling requirement			EN60068-2-1			
Dry heat requirement			EN60068-2-2			
Damp heat requirement			EN60068-2-30			
Shock and vibration			IEC/EN 61373 C1/Body Mounted Class B			

EMC Performances

EMI	CE	EN50121-3-2	150kHz-500kHz 79dBuV	
		EN55016-2-1	500kHz-30MHz 73dBuV	
	RE	EN50121-3-2	30MHz-230MHz 40dBuV/m at 10m	
		EN55016-2-1	230MHz-1GHz 47dBuV/m at 10m	
EMS	ESD	IEC/EN61000-4-2/GB/T 17626.2-2006	Contact ±6KV/Air ±8KV	perf. Criteria A
	RS	IEC/EN61000-4-3/GB/T 17626.3-2006	10V/m	perf. Criteria A
	EFT	IEC/EN61000-4-4/GB/T 17626.4-2008	±2kV 5/50ns 5kHz	perf. Criteria A
	Surge	IEC/EN61000-4-5/GB/T 17626.5-2008	Line to line ± 1KV (42Ω, 0.5μF)	perf. Criteria A
	CS	IEC/EN61000-4-6/GB/T 17626.6-2008	0.15MHz-80MHz 10 Vr.m.s	perf. Criteria A

Physical Characteristics

Case materials	Metal base + plastic case in black, flame class UL94-V0
Cooling method	Conduction cooling or forced air cooling with fan
Unit weight	With Chassis 215g
Unit dimensions	134.0x69.0x27.0 mm (with Chassis)

Mechanical Dimensions and Pin-Out Function Description

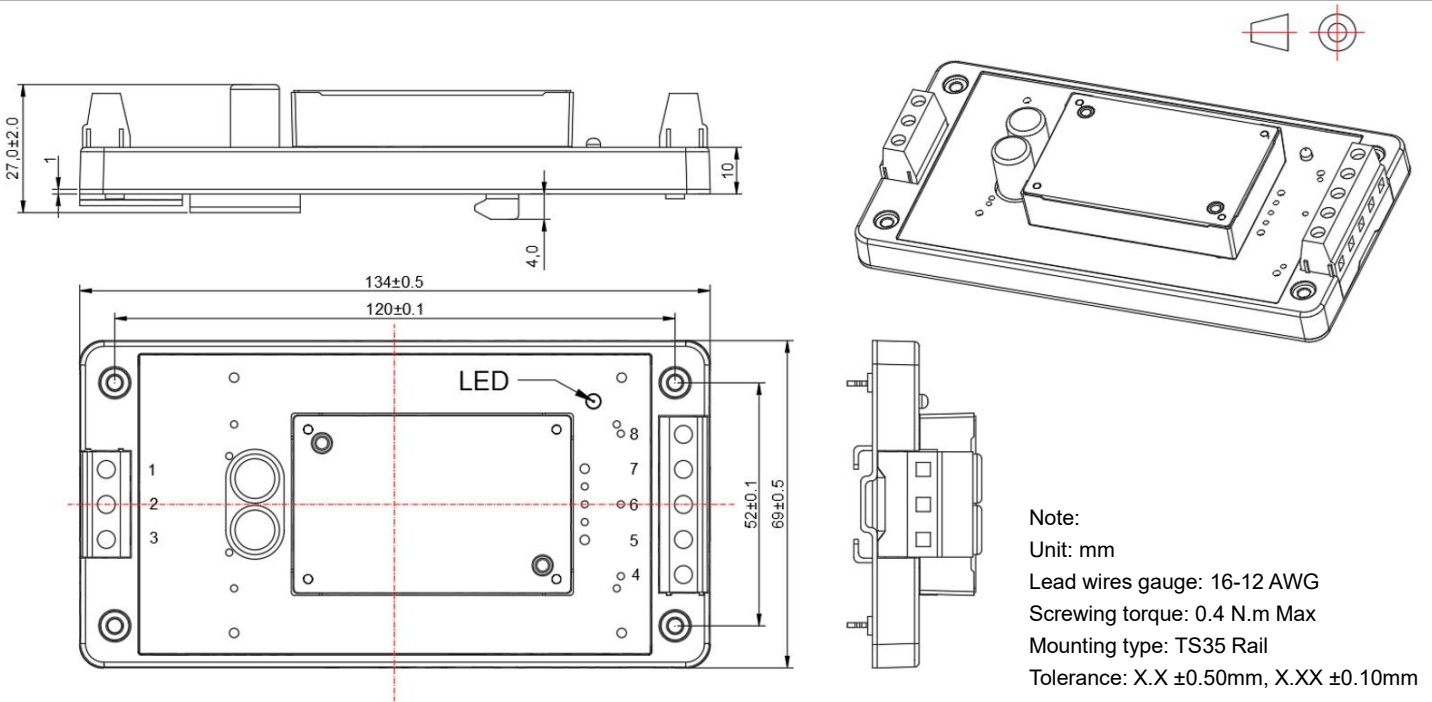

Pin No.	1	2	3	4	5	6	7	8
Function	Vin+	CNT	Vin-	Vout-	-Sense	TRIM	+Sense	Vout+
Description	Input V+	ON/OFF Control	Input V-	Output V-	Output distal end compensation S-	Output Voltage Trim	Output distal end compensation S+	Output V+

Product Characteristics Graphs

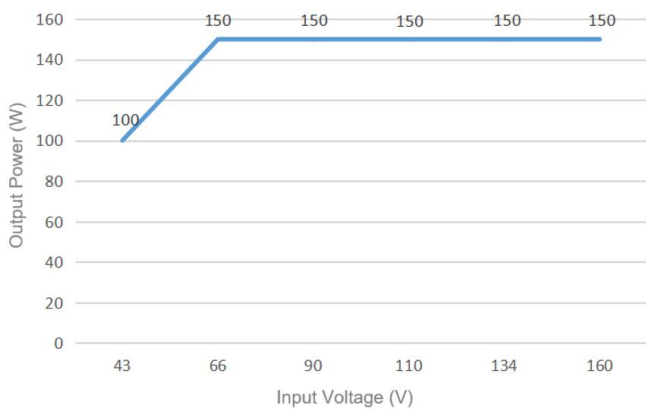
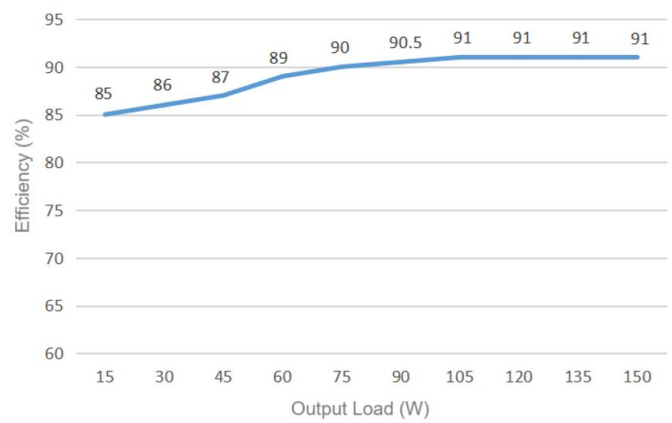
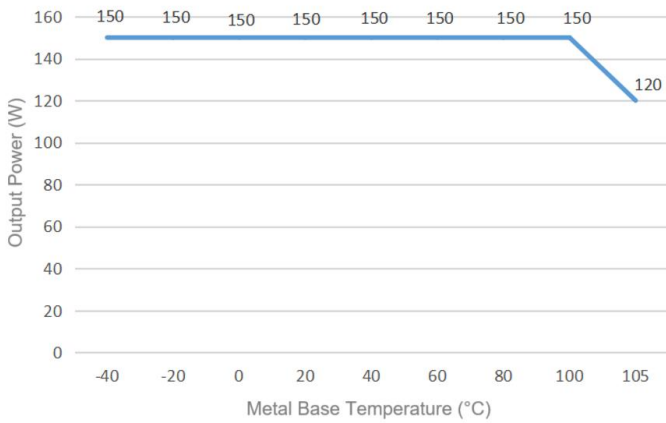

Note 1: The output power and the efficiency in the graphs have been tested with typical values.
 Note 2: The data in temperature derating graph has been tested under Aipu laboratory test conditions. It is recommended to keep the temperature of the Metal Base not more than 100 °C when the converter operates at the rated load for the application.

Recommended circuits for application

1. Ripple & Noise

All this series of converters will be tested according to the circuit diagram below before shipping.

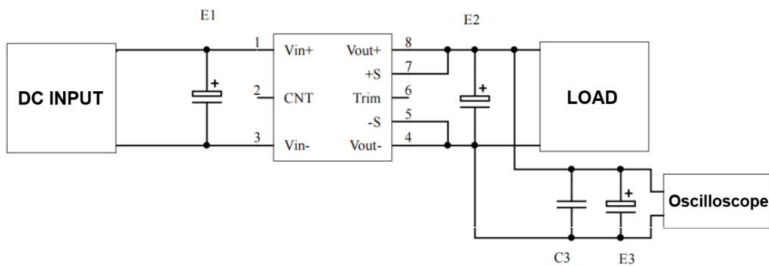

Capacitance	E1 (μF)	E2 (μF)	C3 (μF)	E3 (μF)
Output Volt.				
3.3VDC	100	1000	1	10
5VDC		680		
12VDC		470		
.....				
48VDC				
.....				
110VDC	68	68		

2. Typical application circuit

If this circuit recommended is not adopted, please connect an electrolytic capacitor ≥100 μF in parallel at the input to suppress the possible surge voltage.

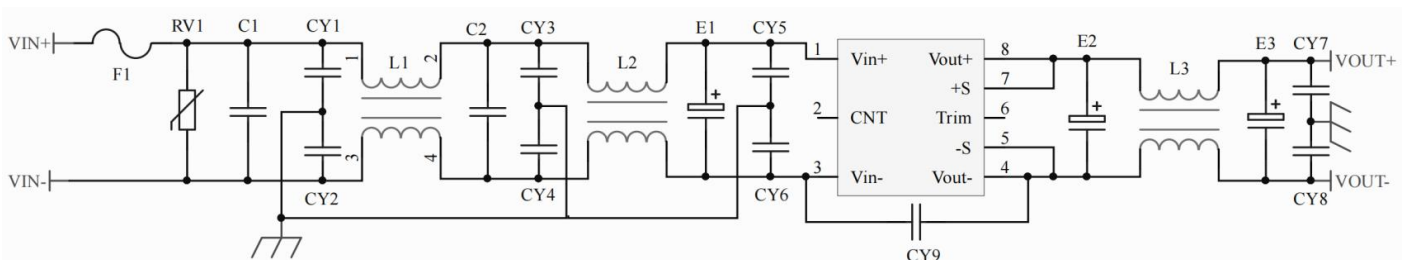

F1	T6.3A/250V Time-delay fuse
RV1	14D 200V Varistor
C1, C2	105/250V Polyester Film Capacitor
CY1, CY2, CY3, CY4, CY5, CY6	102/250Vac Y2 capacitors
CY7, CY8	103/2KV Ceramic SMD Capacitor
CY9	471/250Vac Y1 capacitor
E1	100μF/200V Electrolytic Capacitor
E2, E3	220μF/35V Electrolytic Capacitors
L1, L2	>5mH, temperature rise less than 25°@3A
L3	>220uH, temperature rise less than 25°@6.3A

3. ON/OFF control (CNT) application

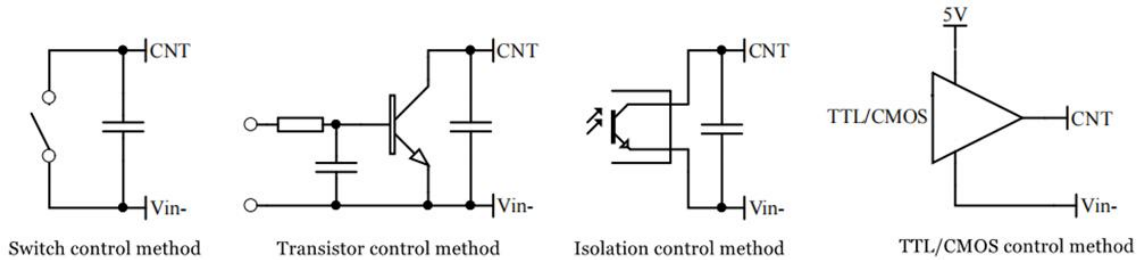

4. Application for Sense

1)With NO distal end compensation

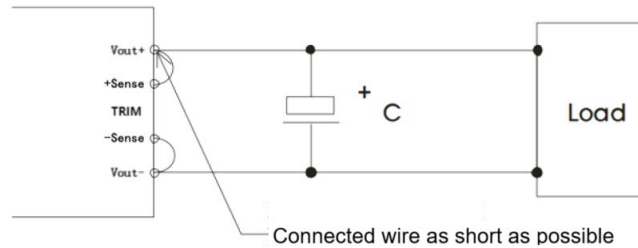

- Notes:
1. Vout+ & Sense+, Vout- & Sense- should be shorted when distal compensation is not needed
 2. The lead wire between Vout+ and Sense+, Vout- and Sense- should be as short as possible, and close to the pins, or else the output may be unstable.

2)With distal end compensation

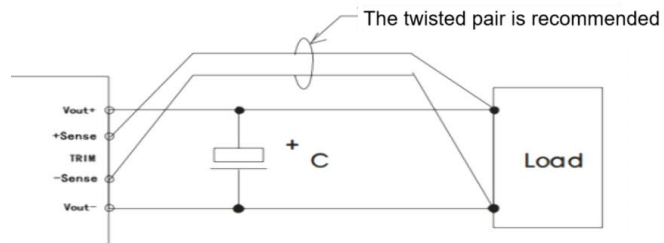

- Notes:
1. The output voltage may be unstable if the compensation cables are too long.
 2. The Twisted pair or shielded cables are recommended, the cable length should be as short as possible.
 3. Wide copper path on PCB or thick lead wires between the power supply and the load should be used to achieve the line voltage drop <0.3V. The target is to keep output voltage within the specified range.
 4. The leads wire resistance may create the output voltage oscillation or larger ripples. Please verify it before to use.

5. TRIM & TRIM resistance calculation

The calculation of ΔU and R_{up} & R_{down} :

$$R_{up} = 70 / \Delta U - 20 (K\Omega)$$

$$R_{down} = 28 * (24 - 2.5 - \Delta U) / \Delta U - 20 (K\Omega)$$

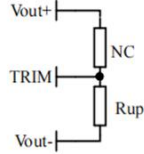

Voltage-up: Add R_{up} between Trim and Vout-

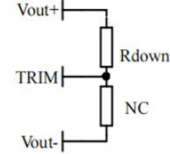

Voltage-down: Add R_{down} between Trim and Vout+

6. This converter is not available to be connected in parallel to increase the output power. Please contact Aipu technician for this kind of requirement.

Others

1. The product warranty period is two years. The failed product can be repaired/replaced free of charge if it operates at normal condition. A paid service shall be also provided if the product fails after operating under wrong or unreasonable conditions.
2. Aipupower can provide customization design and filter modules for matching, please contact our technician for details.

Guangzhou Aipu Electron Technology Co., Ltd

Address: Building 4, HEDY Park, No.63, Punan Road, Huangpu Dist, Guangzhou, China.

Tel: 86-20-84206763 Fax: 86-20-84206762 HOTLINE: 400-889-8821

E-mail: sales@aipu-elec.com Website: www.aipupower.com